



# GP 12340 ▶ 12V 34Ah

GP 12340 is a general purpose battery up to 5 years in standby service or more than 260 cycles at 100% discharge in cycle service. As with all CSB batteries, all are rechargeable, highly efficient, leak proof and maintenance free.



## ► Specification

Cells Per Unit	6
Voltage Per Unit	12
Capacity	34 Ah @ 20hr-rate to 1.75V per cell @25°C (77°F)
Weight	Approx. 10.48 kg(23.06 lbs)
Maximum Discharge Current	380A(5sec)
Internal Resistance	Approx. 8 mΩ
Operating Temperature Range	Discharge: -15°C~50°C ( 5°F~122°F) Charge: -15°C~40°C ( 5°F~104°F) Storage: -15°C~40°C ( 5°F~104°F)
Nominal Operating Temperature Range	25°C±3°C (77°F±5°F)
Float Charging Voltage	13.5 to 13.8 VDC/unit Average at 25°C(77°F)
Recommended Maximum Charging Current Limit	10.2A
Equalization and Cycle Service	14.4 to 15.0 VDC/unit Average at 25°C(77°F)
Self Discharge	CSB Batteries can be stored for more than 6 months at 25°C(77°F). Please charge batteries before using. For higher temperatures the time interval will be shorter.
Terminal	B5-L terminal to accept M6 nut & bolt
Container Material	ABS(UL 94-HB) & Flammability resistance of (UL 94-V0) can be available upon request.



CSB-manufactured VRLA batteries are UL-recognized components under UL924 and UL1989.

CSB is also certified by ISO 9001 and ISO 14001.

Dimensions :	Overall Height (H)	Container height (h)	Length (L)	Width (W)
Unit: mm (inch)	178.3±2 (7.02±0.08)	154.8±2 (6.09±0.08)	195.6±2 (7.7±0.08)	130±1.5 (5.12±0.06)

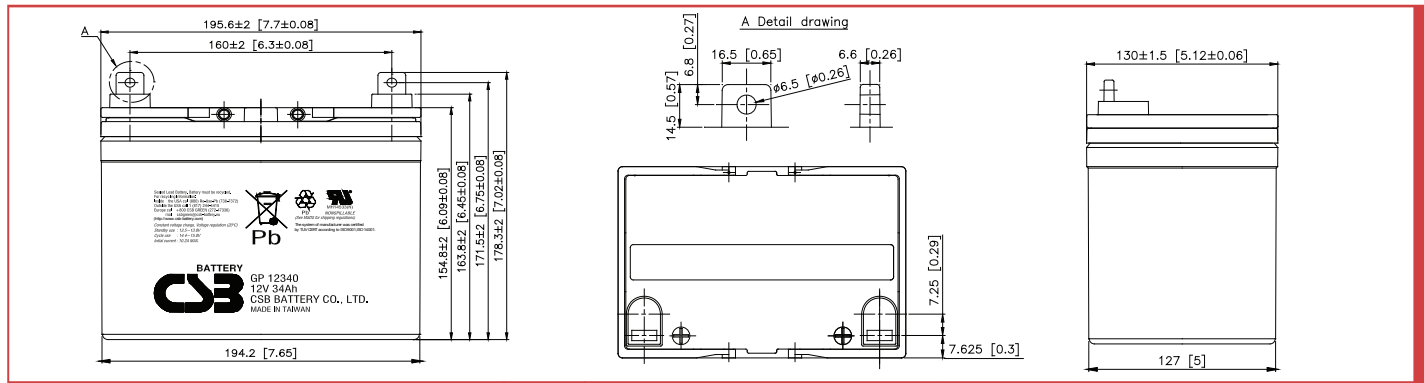

## Constant Current Discharge Characteristics Unit:A (25°C,77°F)

F.V/Time	5MIN	10MIN	15MIN	30MIN	60MIN	90MIN	2HR	3HR	5HR	8HR	10HR	20HR
1.60V	144	91.7	69.3	42.1	25.0	18.2	14.5	10.3	6.55	4.26	3.48	1.86
1.67V	128	85.5	65.5	41.3	24.7	18.0	14.4	10.2	6.50	4.23	3.43	1.78
1.70V	121	82.8	63.8	40.8	24.5	17.9	14.3	10.1	6.49	4.23	3.41	1.75
1.75V	110	77.5	61.2	40.0	24.4	17.8	14.2	10.0	6.47	4.18	3.35	1.69
1.80V	98.0	72.3	58.8	39.2	24.0	17.6	14.1	9.9	6.45	4.14	3.30	1.64
1.85V	86.3	67.0	55.7	38.2	23.6	17.4	14.0	9.8	6.43	4.09	3.24	1.58

## Constant Power Discharge Characteristics Unit:W (25°C,77°F)

F.V/Time	5MIN	10MIN	15MIN	30MIN	60MIN	90MIN	2HR	3HR	5HR	8HR	10HR	20HR
1.60V	1732	1100	832	505	300	218	174	124	78.6	51.1	41.7	21.6
1.67V	1539	1026	788	495	297	216	173	123	78.1	50.8	41.1	20.7
1.70V	1456	994	771	490	295	215	172	122	77.9	50.7	40.9	20.3
1.75V	1316	931	739	481	292	213	171	121	77.7	50.2	40.3	19.6
1.80V	1176	867	705	470	288	212	170	120	77.4	49.6	39.6	18.9
1.85V	1036	804	669	458	283	209	169	119	77.2	49.1	39.0	18.2

### Trickle (or Float) Service Life

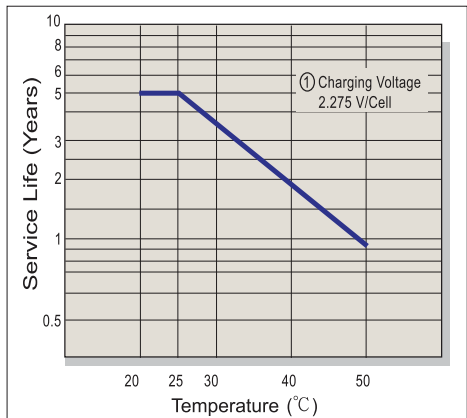

### Capacity Retention Characteristic

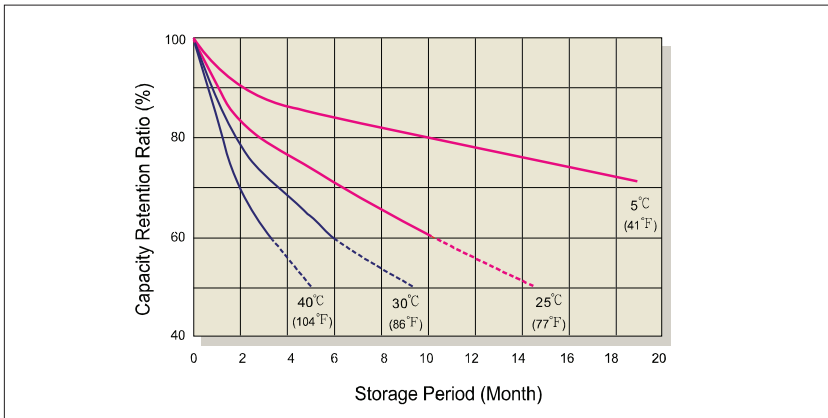

### Battery Voltage and Charge Time for Standby Use

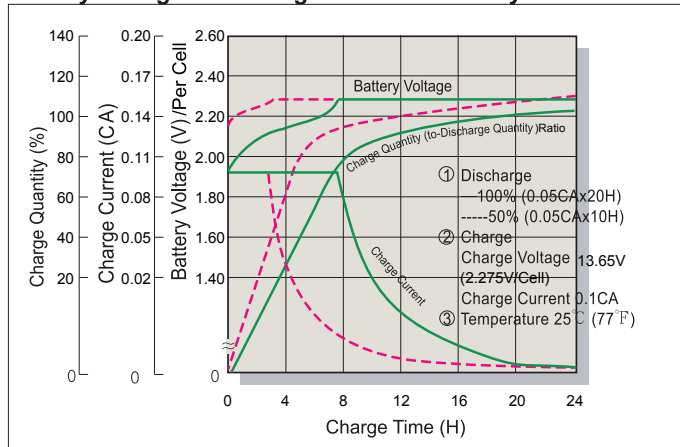

### Cycle Service Life

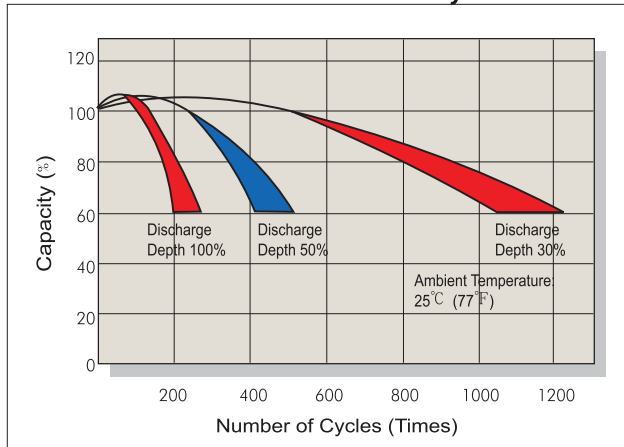

### Battery Voltage and Charge Time for Cycle Use

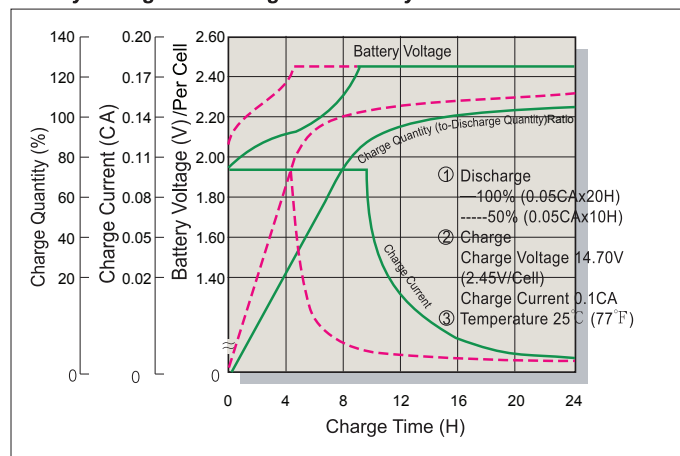

### Terminal Voltage (V) and Discharge Time

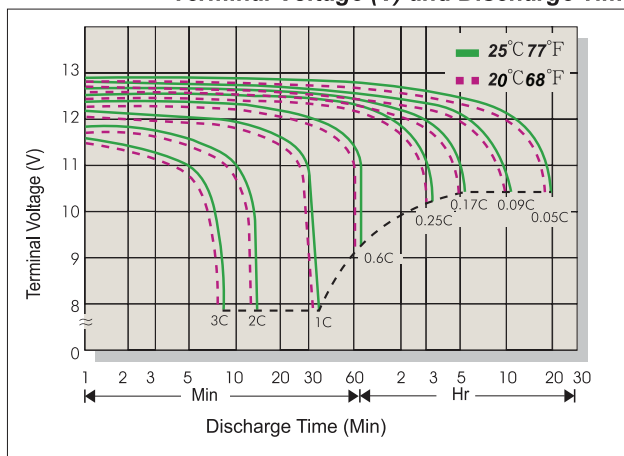

### Charging Procedures

Application	Charge Voltage(V/Cell)			Max.Charge Current
	Temperature	Set Point	Allowable Range	
Cycle Use	25°C(77°F)	2.45	2.40~2.50	0.3C
Standby	25°C(77°F)	2.275	2.25~2.30	

### Discharge Current VS. Discharge Voltage

Final Discharge Voltage V/Cell	1.75	1.70	1.60	1.30
Discharge Current(A)	0.2C>(A)	0.2C<(A)<0.5C	0.5C<(A)<1.0C	(A)>1.0C

Sales Office URL: [WWW.CSB-BATTERY.COM](http://WWW.CSB-BATTERY.COM)

**GLOBAL HQ**  
**CSB BATTERY CO., LTD. (TAIWAN)**  
 Tel : +886-2-2880-5600  
 Fax : +886-2-2888-3300  
 mail : service@csb-battery.com.tw

**BEIJING OFFICE. (CHINA)**  
**CSB BATTERY TECHNOLOGIES (BEIJING) CO., LTD.**  
 Tel : +86-10-5820-5336/5338  
 Fax : +86-10-58203053  
 mail : chinasis@csb-battery.com

**AMERICA HQ**  
**CSB BATTERY TECHNOLOGIES INC. (U.S.A)**  
 Tel : +1-817-244-7777/1-(800)3-CSB-USA(272872)  
 Fax : +1-817-244-4445  
 mail : csb@csb-battery.com

**SHANGHAI OFFICE. (CHINA)**  
**CSB BATTERY LOGISTIC (SHANGHAI) CO., LTD.**  
 Tel : +86-21-5046-1622/5046-0833  
 Fax : +86-21-5064-1046  
 mail : chinasis@csb-battery.com

**EUROPE HQ**  
**CSB Battery Europe BV.**  
 Tel : +31(0)-180-418-140  
 Fax : +31(0)-180-418-327  
 mail : eurosales@csb-battery.eu

**SHENZHEN OFFICE. (CHINA)**  
**CSB BATTERY LOGISTIC (SHANGHAI) CO., LTD.**  
 Tel : +86-755-8831-6488/6396/6356  
 Fax : +86-755-8831-6548  
 mail : she@csb-battery.com.cn